

A powerful and cost effective integrated CAD, CAM and IT solution for design, manufacture and IT application development.

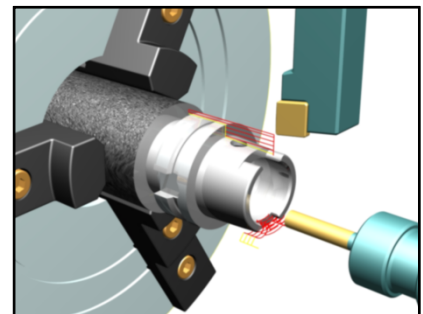

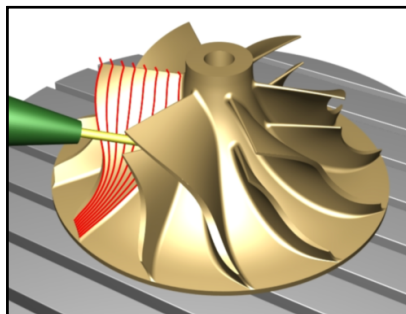
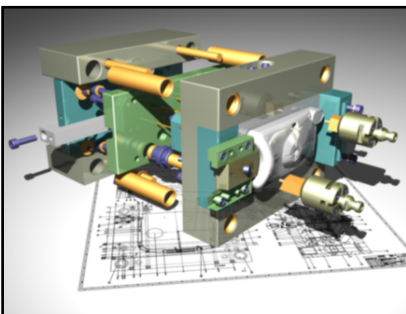
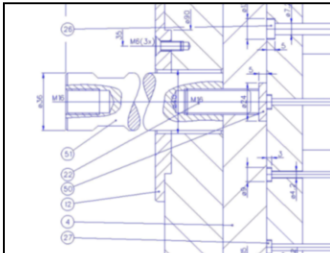
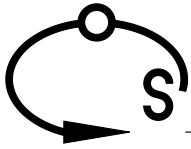

2D Mechanical and General CAD

Dedicated professional 2D CAD for general drafting, in addition to mechanical, architectural and electrical design. Streamline drawing production with automated features such as DIN/ISO screw connections, detail views, gears and bearings, and specialist industry 2D CAD libraries.

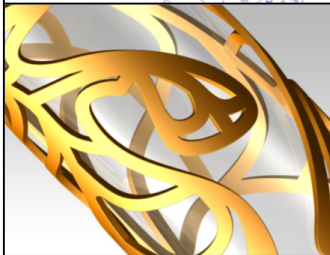

Graphic Design and Artistic CAD

Bring your 2D concepts to life with artistic CAD. Vectorise and smooth your sketched ideas, as well as import and edit downloaded cliparts. Use our suite of Bezier based tools to create stunning graphic designs, in addition to realising ideas in 3D with our artistic sculpting tools.

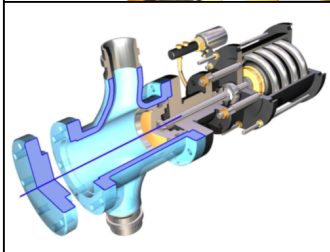

3D Solid Modelling

Take a design from conception through to 3D digital prototyping with state of the art solid modelling. Use deforming and shaping techniques for complex product design, and quickly construct typical 3D architectural and mechanical models helped by our large assembly performance.

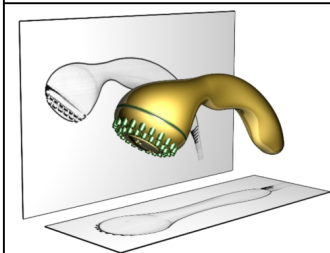

3D Surface Modelling

Construct highly intricate forms using our professional surfacing suite. Model new concepts, and repair poorly imported 3D data with our Bezier, Nurbs and ACIS based tools. Combine solid and surface design using hybrid modelling techniques, and reverse engineer existing 3D mesh data.

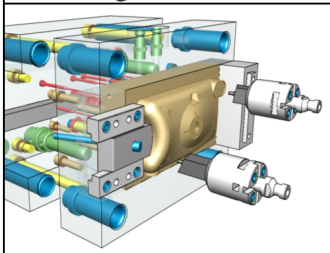

Moldtool Design

Analyse parts for their moldability, checking for undercuts and draft angle. Create separate core and cavity blocks, including automatic parting line and surface generation. Design electrodes, and construct, assemble and animate complete mold tools and associated components.

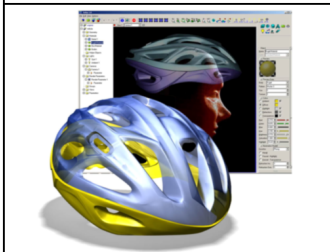

Technical Documentation, Rendering and Animation

Generate stunning photo realistic computer visuals and animated marketing presentations direct from your 3D designs. Produce product technical documentation by combining visuals, photos, CAD drawings, graphics, text and tables all within a single layout ready for publication.

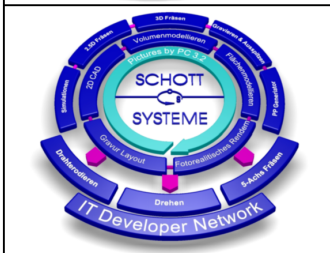

Business Management Graphics

Create automatic 2D/3D business graphics to transform simple text into stunning visuals for professional company presentations. Turn rough project ideas into intelligent structural graphics and organisational overviews. Make your projects portable with our linked PDF presentations.

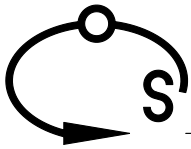

2.5D Milling and Drilling

Apply 2.5D milling/drilling and 3+2 multisided machining to both 2D drawings and 3D solid models. Re-use machining methods to instantly pocket, rest machine and finish parts. Automate drilling with 2D/3D hole recognition, then simulate machining and generate NC programmes.

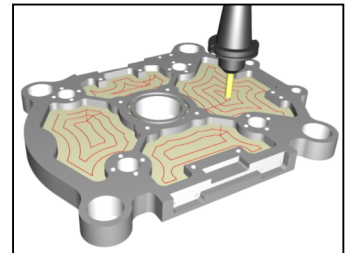

3D Surface and Solid Milling

Apply 3D milling strategies to freeform solid, surface and mesh models. Reduce traditional machining time using our advanced roughing and rest milling techniques. Choose from a range of versatile finishing operations, and reduce operator hours using our unique freeform feature recognition.

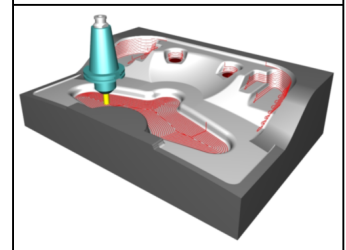

Professional Engraving and Carving

Professional engraving for sign writing, jewelry design and mold work. Apply 2D engraving to CAD designs, imported graphics (*.ai, *.eps, *.wmf) or vectorised scanned images. Automatic projection onto 3D solids and surfaces. Includes 4 axis rotary and 5 axis simultaneous engraving.



WireEDM

Wire cut intricate parts with our wireEDM module. Generate machining from 2D drawings and 3D solid models. Instantly apply typical cutting methods including profiling, pocketing and synchronised 4 axis machining. Maintain full control over lead-in/out, tapers, tagging and registry settings.

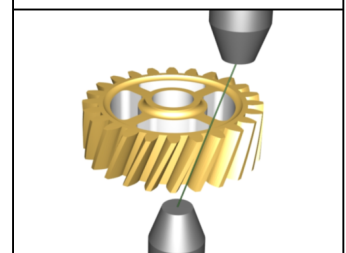

Turning and Turn/Mill

2 axis turning and prepositional turn/milling. Apply roughing, finishing, threading and cutoff operations. Single point machining includes drilling, boring, reaming and tapping cycles. Use feature wizards to automatically define common profiles such as standard and thread grooves.

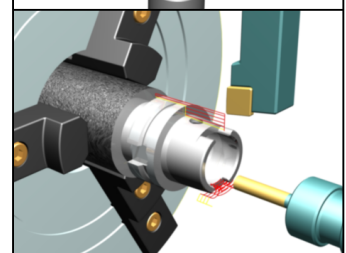

5 Axis Simultaneous Milling and Cutting

Reduce milling time with single machining setups, and increase surface quality by using shorter milling tools. Apply dedicated 5 axis simultaneous techniques to solid, surface and mesh models with chamfer cutting, swarf cutting, finishing, profile cutting and engraving operations.

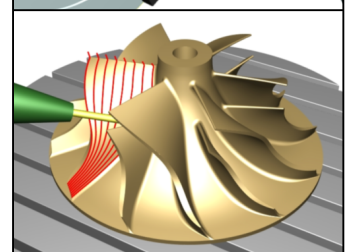

Customer Care and Support

Schott Systeme's customer care includes free lifetime software support via telephone and email, in addition to free project based elearning for quick and intensive training. Keeping customer costs to a minimum, Pictures by PC also includes free standard CAM post processors.

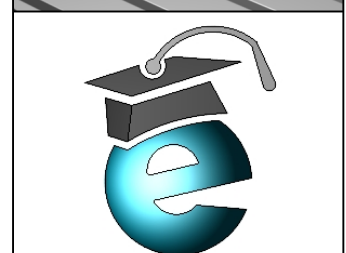

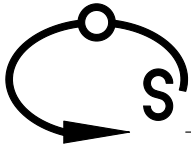

Pictures by PC Price List

All prices are in Euros and are subject to VAT

Integrated 2D/3D Design and Machining

3D Modelling, CAM and Exchange. Includes 2D CAD, graphic design, professional font work, tri-brid 3D solid, surface and mesh modelling, 3D model repair and healing, data import, photo realistic rendering and animation, 2.5D milling and drilling, 3D surface machining, hole and freeform feature recognition, engraving / carving and 3+2 axis multisided milling. **€ 9.800,-**

Subsequent Full License **€ 8.000,-**

Machine Post Processors

All post processors for machines up to and including 3+2 axis multi sided milling are included free of charge. A post processor generator is also provided for customer modifications, and DNC communication software via RS232 and V24 comes as standard. **Inclusive**

Customer Care Package

Our customer care package includes free lifetime software support via telephone and email, in addition to free project based elearning for quick and intensive training. **Inclusive**

Individual Component Pricing

Pictures by PC Modelling

2D/3D design, modelling, graphics and technical documentation. **€ 2.800,-**
Second and subsequent licenses. **€ 2.000,-**

CAM

Purchased as an addition to the Pictures Modeller - Includes 2.5D and 3D milling / drilling, engraving and up to 3+2 axis prepositional machining. **€ 6.000,-**
Second and subsequent licenses. **€ 4.500,-**

Additional CAM Modules

WireEDM. **€ 2.000,-**
Turning. **€ 2.000,-**
5 Axis Simultaneous Milling. **€ 2.500,-**

Exchange Package

Import of STEP, IGES surfaces / solids and VDA-FS 3D data formats. Included as standard within the Pictures Modeller are STL, SAT, DXF, AI, EPS, 3DS, WMF, EMF, OBJ and HPGL. **€ 2.000,-**

Business Management Graphics

A unique solution for graphical business planning and company presentations based around our 3D Modeller. Generate stunning business presentations from simple text lists. Visually plan and organise projects with graphical structure layouts. Create portable projects using linked PDF. **€ 2.800,-**

IT Developer Network

Streamline business processes, and enhance the communication between your company's differing systems with our IT developer network. Join the annual subscription based club, and receive numerous IT dragees to automate all aspects of your business, including the award winning information search system for knowledge based searches. **€ 1.000,- per year**